



SCOOT

User Manual

Mobility Rider
for Little Explorers

For French, Italian, Spanish, German, Portuguese
and Swedish please refer to our website.

www.fireflyfriends.com

Please read all instructions carefully before using Scoot. All instructions can also be found on our website **www.fireflyfriends.com** along with videos, diagrams and FAQs.

Contents

01 Intended Use	p.03
02 Declaration of Conformity	p.04
03 Terms of Warranty	p.04
04 Safety Information	p.05
05 Cleaning and Care Information	p.06
06 Daily Product Inspection & Servicing	p.07
07 Reissuing Firefly Products	p.08
08 Product Servicing	p.08
09 Instructions for use	p.09
9.1 How to know whether Scoot is suitable for your child	p.09
9.2 How to unpack and assemble your Scoot	p.10
9.3 Transferring your child in to Scoot	p.16
9.4 How to use Scoot	p.20
10 Technical Information	p.21
11 Frequently asked questions	p.22

SECTION 01: Intended Use

The Scoot is a 4-in-1 mobility rider designed to let children with special needs play, explore and participate in a way that suits their physical and cognitive abilities.

The Scoot should not be used on rough or uneven terrain. Smooth surfaces such as concrete or wooden decking are recommended.

Across both configurations, there are four different functions: Crawl, Scoot, Ride and Poosh.

Crawl: Lying on tummy and propelling with arms and feet

Scoot: Seated and propelling with feet

Ride: Seated and self-propelling using wheels

Poosh: Seated in the Ride configuration and being pushed by an adult using the push handle

Scoot is generally suitable for children aged 2-6, however suitability depends on the child's level of physical development, hip-width and leg-length (for more information on this, please see Section 10).

Scoot Parts



Backrest



Poosh Pole

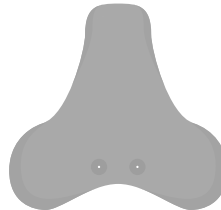

Scoot Base



Padded Cover

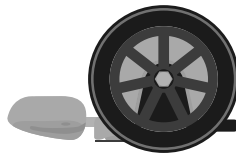

Wheel assembly

We recommend the supervising adult performs daily product inspections (according to Section 6 of this manual) to ensure safe use of the product.

James Leckey Design Ltd cannot accept any responsibility if the product is used outside of its intended safe use. If in any doubt, please contact Firefly Customer Services on UK 0800 318265 or ROI 1800 626020 or customer.enquiries@fireflyfriends.com.

SECTION 02: Declaration of Conformity

James Leckey Design Ltd, as manufacturer with sole responsibility for the Firefly brand, declares that the Scoot conforms to the requirements of the 93/42/EEC Guidelines and EN12182 Technical Aids for Disabled Persons, General Requirements and Test Methods.

SECTION 03: Terms of Warranty

UK / ROI: Goods can be returned to us for warranty repair or replacement up to 12 months from receipt. In all cases, it is the customer's responsibility to ensure the goods being returned are suitably packaged, preferably in the original packaging.

International Customers: Goods can be returned to us for warranty repair or replacement up to 12 months from receipt. Please contact us to obtain a case reference ID as per the International Returns procedure. The customer is responsible for the cost of returning the goods. Once returned to us we will repair or replace your goods and return them to you within 14 days.

SECTION 04: Safety Information

1. Failure to follow the instructions may put you and/or your child at risk. Always read user instructions fully before use.
2. The Scoot must be used under adult supervision at all times.
3. Check all components are securely fastened before use.
4. Do not modify your Scoot or use components other than Firefly-approved components with it at any time. The Scoot should not be used if any of its components are faulty.
5. Do not attempt to use alternative fittings if part of Scoot becomes lost – spare parts are available by contacting Customer Services on UK 0800 318265, ROI 1800 626020 or customer.enquiries@fireflyfriends.com
6. Keep any of the loose bolts, tools and fixings supplied with your Scoot away from small children as they can present a choking hazard.

7. Always remember that Scoot does not have brakes, so should only be used on flat, level surfaces. Scoot should not be used on or near steps or stairs.
8. Carry-out any positional adjustments and ensure that the belt buckle is fully fastened and the belt is adjusted to fit your child whilst seated. In the Ride format, the footrest should be adjusted so your child's feet do not extend beyond the end of the footrest.
9. The Poosh pole should only be used when Scoot is set up in the Ride configuration, with the bigger wheel assembly. It is not safe to use the pole in the Scoot set up, which is intended for children who will self-propel using their legs. Ensure that Scoot remains steady or backed-up against a wall before transferring your child into it.
10. If your child is using Scoot outside and self-propelling in the Ride configuration, it is vital that you check the wheels are clean at all times.
11. When not in use, the Scoot should be stored carefully in a dry place away from extreme temperatures.
12. Check the surroundings are safe before allowing your child to use Scoot. Household items or furniture can present dangers if they have sharp corners or create obstacles.
13. Do not force movement as you could harm your child.
14. We recommend your child wears trainers (sneakers) when using the product for safety reasons. Bare feet, sandals or slippers are not advised.
15. When assembling the Ride configuration ensure that the wheelguard fixings are secure and the footrest has been adjusted and secured according to Section 9.2.
16. If in any doubt about the safe use of the Scoot or if any parts should fail, please cease using the product immediately and contact Firefly Customer Services on UK 0800 318265, ROI 1800 626020 or customer.enquiries@fireflyfriends.com
17. The Scoot upholstery complies with fire safety regulations in accordance with EN1021-1. However the product should be kept away from naked flames.
18. Clean the product regularly in accordance with Section 5 of this manual. Do not use abrasive cleaners. Carry out maintenance checks on a regular basis to ensure your product is in good working condition.

SECTION 5: Cleaning and Care Information

The plastic surfaces on Scoot may be wiped clean with warm soapy water and a soft cloth or sponge. Any abrasive cleaning agent may scratch or mark the Scoot.

Do not clean any of the Scoot's parts with any cleaning agent containing bleach.

Hip Belt and Cushion

- The belt may be removed from the backrest for washing using the tool enclosed in the instruction pack. Keep the attachment bolts in a safe place and away from children.
- Upholstery can be placed into the washing machine and washed at 40°C or lower. When washing the Scoot cushion or belt for the first time, wash them separately from other garments to reduce the risk of colour run.
- Do not tumble dry or iron the cushion or belt.
- Remove staining as quickly as possible with an absorbent cloth, towel or sponge. Soap and warm water sponging is effective for ordinary soiling and minor spills, but be careful not to saturate the fabric as it could cause the stain to spread.
- Antiseptic cleaning agents can be used on more stubborn stains. Ensure that cleaning products are fully removed.
- Do not use solvents to clean or remove stains from the belt or cushion.
- Do not bleach the product.
- Do not dry clean the cushion or hip belt.

SECTION 6: Daily Product Inspection

We recommend that various checks on the Scoot are performed before use to ensure the product is safe. The recommended checks are detailed below.

Crawl

1. Check the cushion is attached firmly as shown in Section 9.2.
2. Check the elastic is not loose or in contact with other fittings.
3. Check the elastic is not twisted.
4. Check the front caster is fitted and secure.

Scoot

5. Ensure the backrest is attached securely without any movement.
6. If using the cover then also make checks 1-3.
7. Ensure the belt is fastened securely to the backrest and that the buckle works properly.
8. Check the front caster is fitted and secure.

Ride

9. Ensure the fastenings for the wheel assembly are secure.
10. Ensure backrest is attached as per checks 5-8.

11. If using the cover make checks 1-3.
12. Check that the wheel assembly is attached securely (see Section 9.2 Steps 4-7).
13. Ensure the footrest is adjusted to suit your child.
14. Ensure the footrest is secure.
15. Check the front caster has been removed from the base.

Poosh

16. Ensure the backrest is secure as per checks 5-8.
17. Ensure the push pole is secure as per Step 8 on p.15.
18. Ensure the soft touch knobs on the push handle are secure and screwed on tightly.

Advanced Backrest Cushion

19. Ensure the Advanced Backrest Cushion cover is on correctly as per p.15
20. Make sure the poppers on the laterals are attached correctly as per p.15

If in any doubt about the continued safe use of your Firefly product or if any parts should fail, please stop using the product and contact Customer Services as soon as possible.

SECTION 7: Re-issuing Firefly Products

Clean the product thoroughly in accordance with Section 5 of this manual and ensure that a copy of the manual is supplied with the product. If in any doubt about the continued safe use of your Firefly product or if any parts should fail, please cease using the product and contact our Customer Services on UK 0800 318265, ROI 1800 626020 or customer.enquiries@fireflyfriends.com

SECTION 8: Product Servicing

Faulty products can be repaired or replaced by Firefly, if the product is still covered by warranty. We may need to have the product returned to Firefly for further inspection which may incur a small fee for transportation. For all service-related issues contact Customer Services on UK 0800 318265, ROI 1800 626020 or customer.enquiries@fireflyfriends.com

Section 9 Instructions for Use

SECTION 9.1: How to know whether Scoot is suitable for your child

Assessment and Prescription

Scoot is an early mobility product, designed to provide children with a fun experience and the opportunity for independent movement. Scoot has been designed for children ranging from approximately 2–6 years old (depending on their size) and Gross Motor Function Classification System (GMFCS) levels I - IV, depending on their level of development.

Your child will get the most out of Scoot (in all configurations) if they are able to hold their own head up, and have a reasonable level of trunk control, which means they can floor sit with a little pelvic support.

If your child's head control is still developing, we recommend waiting until this improves before using Scoot.

See videos online at www.fireflyfriends.com for further details.



SECTION 9.2: Unpacking and Assembling your Scoot

Take care not to cut through the box as you may damage some of the parts inside. The parts will be contained in polythene bags. Carefully remove them from the box and check you have all the parts required.

How to assemble your Scoot:
Choose which configuration you wish to assemble:

Crawl



Scoot



Ride



Pooosh



Keep polythene bags away from children.

Your Scoot will come with an instruction pack containing all the parts and tools you need for assembly.

Parts included in your Scoot

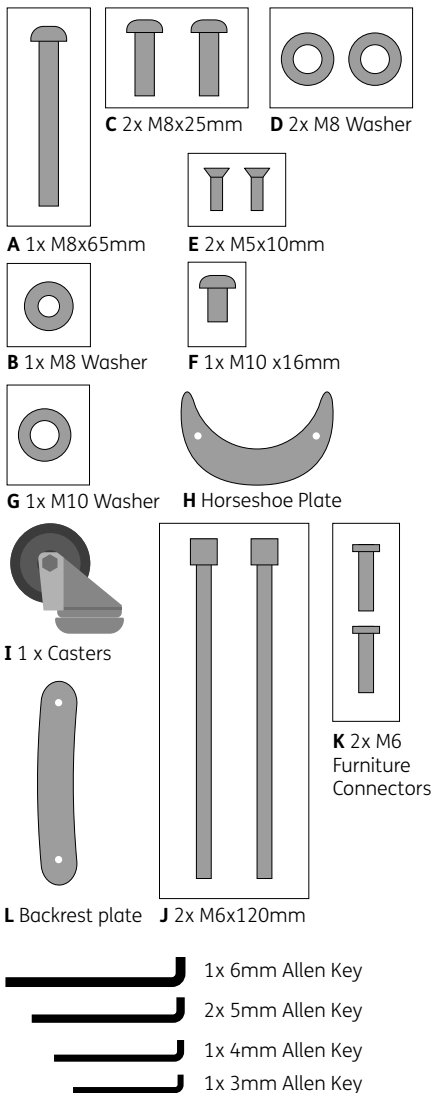

Step 1

If you wish to use Scoot in the Scoot or Crawl configurations you will need to attach the front caster. Take caster I, fitting F and washer G, and affix to the Scoot base with the tool included in the user pack.

The front caster should not be fitted if you are using Scoot in the Ride or Pooosh configuration.

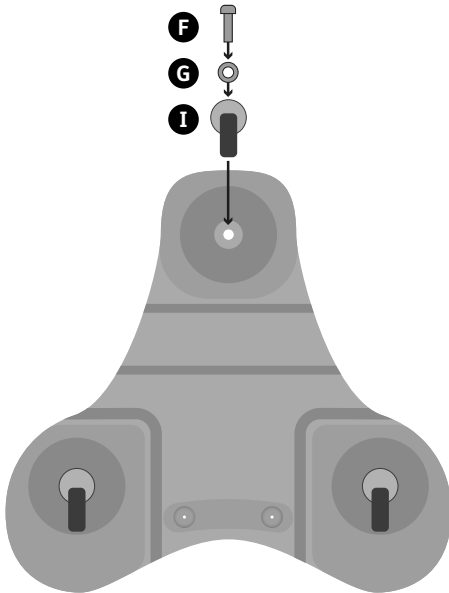

Step 2

Fit the padded cover to the base. Attach the cushion using the elastic straps with the soft side facing up. Align the slot in the upholstery with the two holes in the top of the base.

Your Scoot is now ready to use in the Crawl configuration.

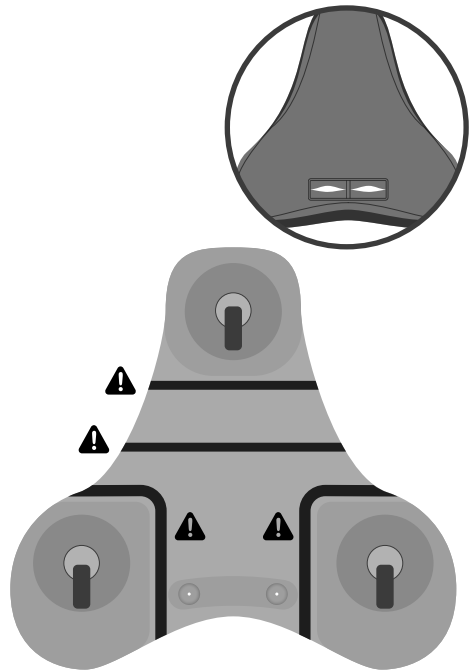

Mount the elastic as shown, ensuring it will not catch in the casters.

Step 3

To attach the backrest, insert backrest fingers through the slots in the upholstery so both sit securely in the holes of the Scoot base.

Fix the backrest, bracket and furniture connectors to the underside with the plate and screws shown. Use the tools provided to tighten the screws and secure the backrest. Ensure that the backrest does not wobble.

You can now use the product in the Scoot configuration.

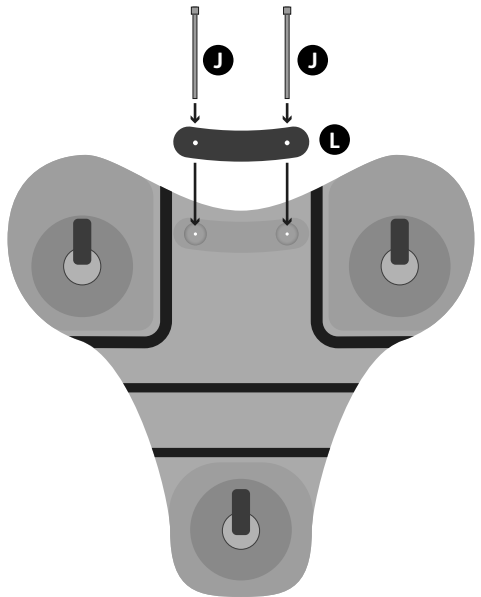
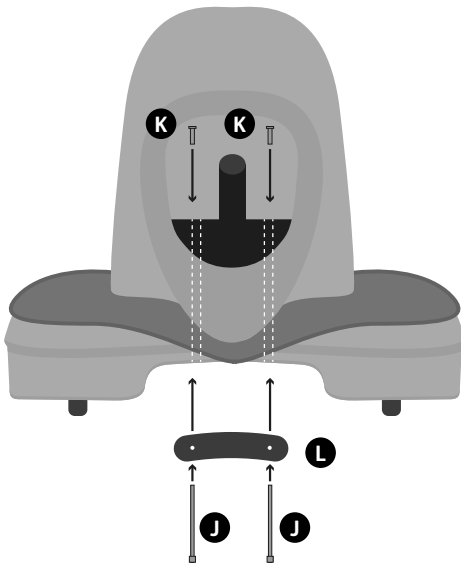

If there is movement in the backrest, tighten the bolts until they feel appropriately tight in your hand.

Step 4

Slide the Scoot base up and onto the three protruding fingers of the wheel assembly so they fit into their corresponding holes.

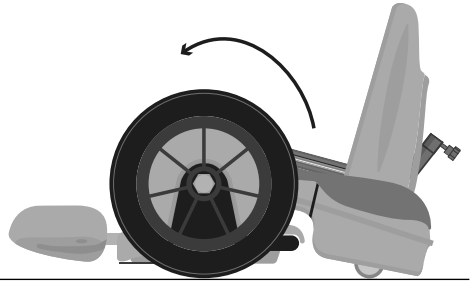

Step 5

Flip the Scoot over to access the underside. Using the bolts and washers highlighted, secure the Ride in three locations using the tool provided.



Check the wheel assembly is secure.

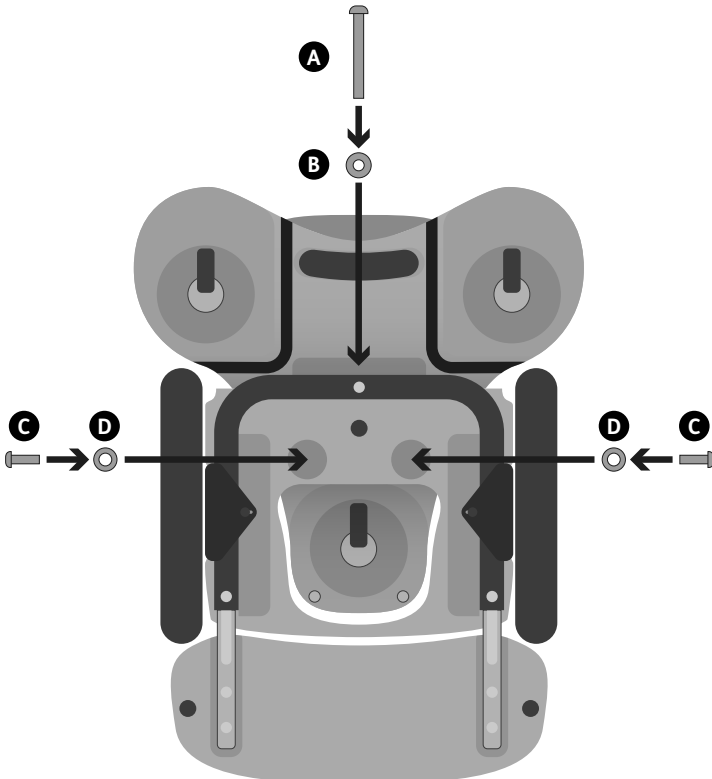

Step 6

Adjust the length of the footrest to suit your child by loosening the highlighted bolts and sliding the footrest in or out.

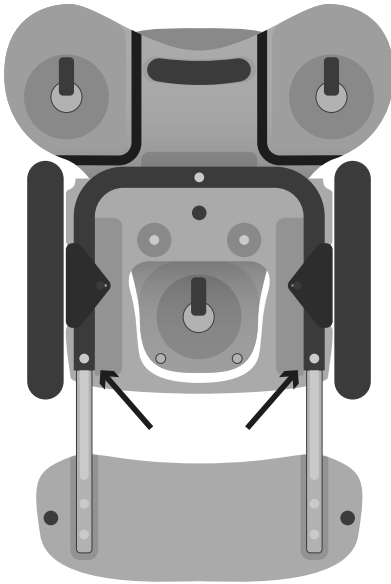

Step 7

Use the two fixings (E) to secure the horseshoe plate (H) to the front of the Scoot as shown.

! In the Ride configuration it is necessary to remove the front caster before use.

Remove the caster and fittings (parts F,G,I) and store in a safe place.

You can now use the Scoot in the Ride configuration.

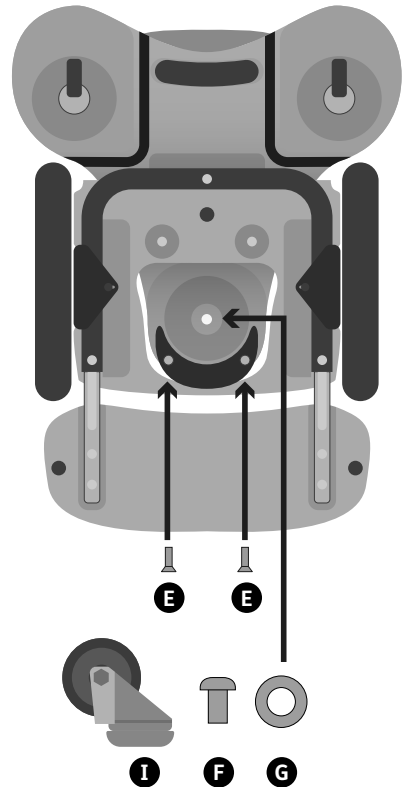

Ensure the bolts are tightened fully before allowing your child to use the Scoot.

Step 8

To attach the push handle place the pole inside the area shown. Tighten screw A to ensure the pole is secure. Adjust the pole to your appropriate height and tighten with screw B.

Ensure that the pole is secure before use.

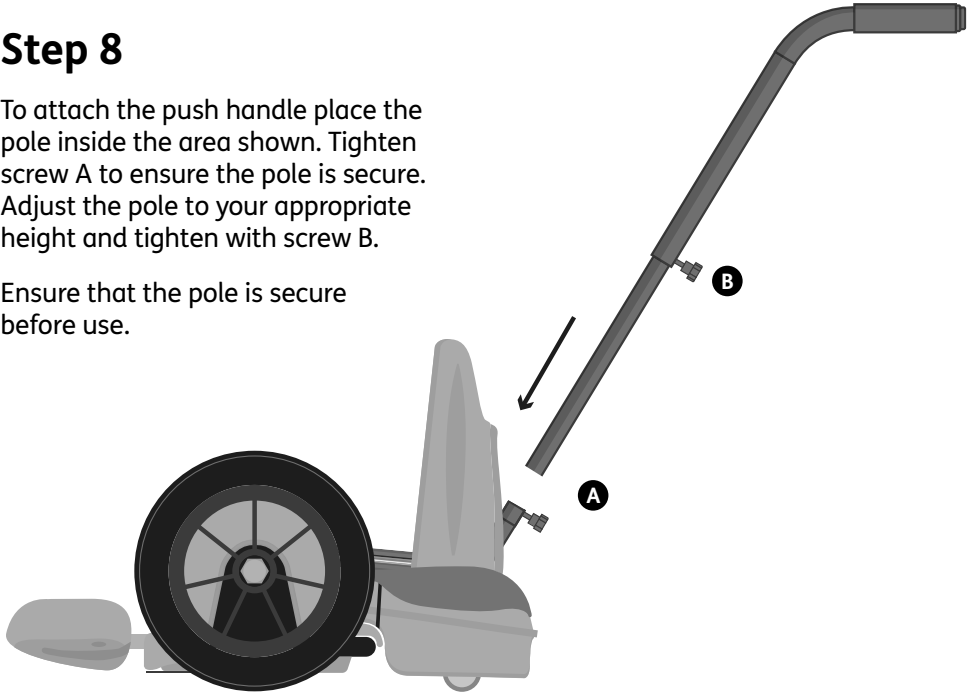

Attaching Advanced Backrest

If you have chosen the Advanced Backrest Cushion as an additional accessory, slide it on to the backrest before attaching the backrest to the Scoot.

Pull the cover over the plastic backrest. Hook the elastic over to secure the cover to the backrest. Hook the tail of the cover over the tail of the backrest. Place your laterals in the slots shown and attach to the poppers.

To adjust the laterals height, move the laterals up and down between the four poppers.

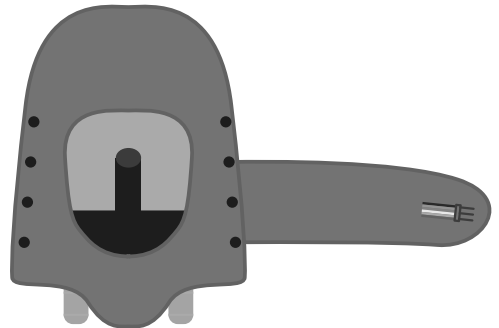
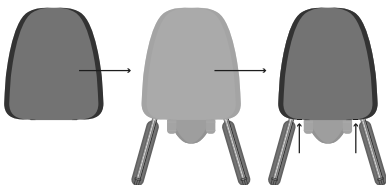

SECTION 9.3: Transferring your child into Scoot

Before you start to use the Scoot, ensure all components are secured and adjusted to fit. Check elastic straps for any sign of damage, wear or tear. If there are any signs of damage, do not use the product and phone Customer Services for advice. Position Scoot so that it will not move whilst your child transfers in to it. Hold it steady or place it against a wall for extra support.

1

Use in Crawl configuration

Your child should use Crawl on their tummy as shown below. The child's head will face the front of the Scoot (where the Firefly logo is located).

Remember there are no brakes on Scoot, so use the Crawl configuration on a flat surface. Supervise your child to ensure they do not reach underneath towards the casters.



2**Use in the Scoot configuration**

Before using Scoot, secure and adjust all components as recommended in Section 9.2 and check elastic straps for any sign of damage, wear or tear. If there is any damage, do not use the product and contact Customer Services for advice. Position Scoot so that it will not move whilst your child transfers in to it.

Hold it steady or place it against a wall for extra support.

Ensure the backrest is attached securely by following the assembly instructions in Section 9.2 Step 3.

Open the belt and position your child so that their back is against the backrest.

Secure the belt around the child's waist. Clip together and pull the two D-rings away from the centre buckle to tighten the belt, ensuring the webbing does not become twisted.

When using the Scoot, your child may propel themselves backwards, forwards or sideways using their legs. Remember there are no brakes on the Scoot, so use it on a flat surface. Supervise your child to ensure they do not reach underneath towards the casters.



Ensure your child is comfortable and stable in the Scoot configuration before use.

3

The Ride Configuration

Adjust and secure all components as recommended in Section 9.2 and check elastic straps for any sign of damage, wear or tear. If there is damage, do not use the product and contact Customer Services for advice. Position Scoot so that it will not move whilst your child transfers in to it.

Adjust the footrest to suit your child's leg-length so that their feet do not extend beyond the end of the footrest. See Section 9.2 Steps 4-6.

Open the belt and ensure it is clear of the seating area. Place your child so that their back is up against the backrest.

Attach the belt around the child's waist. Clip together and pull the two D-rings away from the centre buckle to tighten the belt, ensuring the webbing does not become twisted.

When using Ride, children can propel themselves using the wheels. Pushing both wheels forwards will result in forward movement, and pushing backwards will result in backward movement. Pushing forward on the right wheel will result in a left turn, and pushing forward on the left wheel will result in a right turn. Pushing backwards on the right wheel will result in a right turn, and pushing backwards on the left wheel will result in a left turn.



Ensure your child is comfortable and stable in the Ride configuration before use.

4**Poosh**

Follow the transferring instructions as per the Ride configuration. Ensure the push pole is placed in to the port on the backrest before placing your child in to the Scoot. Ensure both knobs on the push pole are securely fastened. An adult or older child are required to push and supervise the child whilst in Scoot at all times.

Remember there are no brakes on Scoot, so use the Ride configuration on a flat surface. Supervise your child until they are competent at the movements themselves.



Please be aware of the placement of your child's hands when using the Poosh function. Ensure that they are nowhere near the spokes of the wheels to minimise the risk of their hands getting caught.



SECTION 9.4: Scoot and your Child's Development

Whichever configuration of Scoot your child is using, they will have opportunities for developing physical, cognitive, and sensory abilities while having great fun.

Active movement is known to contribute to cognitive development – it helps children learn directional instructions (forwards, backwards etc.) as well as the depth and distance perception needed to negotiate obstacles. In doing so, body awareness improves as your child gets a better sense of how they relate to their environment. This even translates into manipulation and hand-eye coordination. Plus across the variety of configurations, legs, arms, neck, tummy and back can all get a mini work-out. In the Crawl and Ride configurations, little hands are exposed to a wider range of sensory experiences and strengthening of shoulders – this also translates into improved manipulative skills.

All this said, the children we have seen in Scoot aren't interested in any of that – they are too busy zooming around, racing their brothers or sisters and enjoying the freedom that independent mobility brings.

SECTION 10: Technical Information

Footplate Adjustment Distance from Backrest (leg length seated from back to feet)	At minimum setting: 520mm At maximum setting: 630mm (to front of footrest)
Wheel Arch Width	230mm
Seat Width Max Recommended hip width	230mm
Backrest Width	260mm
Backrest Height (from seat)	300mm
Footprint Size	Crawl: L 460mm / W 450mm / H 160mm Scoot: L 460mm / W 450mm / H 320mm Ride (at minimum setting): L 620mm / W 450mm / H 320mm Ride (at maximum setting): L 730mm / W 450mm / H 320mm
Additional Measurements	Backrest: W 260mm Advanced Backrest Laterals: W 420mm Pooosh Pole: H 890mm (max from floor) H 800mm (min from floor)

SECTION 11: Frequently Asked Questions

1. How do I know if Scoot is suitable for my child?

Scoot is an early mobility product, designed to provide children with a fun experience and the opportunity for independent movement. Scoot has been designed for children ranging from approximately 2-6 years old (depending on their size) and Gross Motor Function Classification System (GMFCS) levels I - IV, depending on their level of development.

Your child will get the most out of their Scoot (in all configurations) if they are able to hold their own head up, and have a reasonable level of trunk control which means they can floor sit with a little pelvic support.

Your child will find it difficult to use Scoot in any configuration if they have limited head and trunk control or sitting ability.

However, your child's abilities may still be emerging, so they may be able to manage a short time in Scoot before getting tired. That's OK. Go at their pace, and they may soon build the skills and stamina needed.

For more information on using the Scoot, please see our videos online at www.fireflyfriends.com.

2. Are there any reasons not to use Scoot?

If your child has extremes of tone, or had certain types of surgery (for tight hamstrings, for example), we recommend that you seek advice from your physical therapist and/or physician.

3. How long should my child use Scoot?

This may vary depending on your child's abilities, their mood and the time of day. Be guided by your child, but avoid letting them become too fatigued as this may impact on their abilities in other daily activities.

4. How many times per week should I use Scoot?

Your child may enjoy using Scoot frequently, in which case daily-use may be appropriate. If they have emerging postural skills or sensory issues, you may find that you need to go more slowly.

5. My child doesn't like one of the configurations. What should I do?

Scoot is supposed to be a fun activity which provides therapeutic benefits. A child is most likely to dislike the Crawl configuration, as holding their head up against gravity in this position is the most difficult activity. If you wish to work on head control, then you may wish to encourage this little by little, but otherwise, don't force your child. You don't have to use the Scoot in every configuration.

6. My child has quite high/low muscle tone. Can she use Scoot?

If your child has extremes of tone, they may find it difficult to use the Scoot. If you're in any doubt, please consult with your therapist.

7. Can I use Scoot outside?

Scoot can be used outside on flat, level surfaces. Gravel and grass are not recommended. If your child is self-propelling, it is vital that you check the wheels are clean at all times.



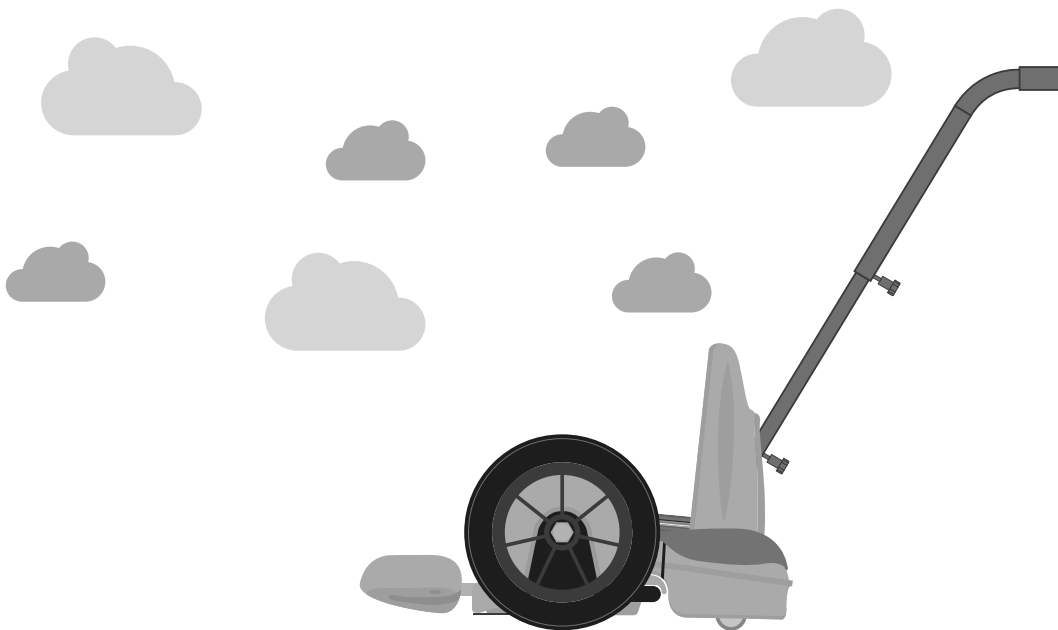

Firefly by Leckey,
19c Ballinderry Road,
Lisburn,
Northern Ireland,
BT28 2SA

UK 0800 318 265
customer.enquiries@fireflyfriends.com

www.fireflyfriends.com



LS328-04